

## Hotpoint Service and Spares

FOR SERVICE: If you have a problem with your appliance ring your local Service Office.  
 FOR SPARES and ACCESSORIES: To purchase spares and accessories send your Accessories Order Form to your Spares Centre. If the accessory or spare part you want is not on the form, contact your Spares Centre for prices and availability.  
 Please address all correspondence to Hotpoint Spares Centre or Hotpoint Service Office as applicable.

Service Offices and Spares Centres are open between 8.00am-5.00pm Monday to Friday, except on Public Holidays. 8.30am-12.30pm on Saturdays.

### EAST

● **ESSEX:** Industrial Buildings, Beehive Lane, Chelmsford, CM2 9TE. Post Codes RM & IG. Tel: (0245) 492433

Remainder of Essex. Tel: (0245) 269331

● **LUTON:** 5 Crawley Road, LU1 1HK. Tel: (0528) 462211

● **NORWICH:** 92 Upper St Giles Street, NR2 1LJ. Tel: (0603) 620561

● **PETERBOROUGH:** Cella Road, PE2 9JB. Tel: (0733) 64741

For Spares Spares Administration Dept. Tel: (0733) 66969

### LONDON

● **WEMBLEY:**

For Service 68 East Lane, HA9 7PQ.

S. Herts and Middlesex Tel: 081-904-4399

Post Codes N, NW, E, EC Tel: 081-908-4722

Post Codes W, WC, SE, SW Tel: 081-908-2511

Tel: 081-904-0201

### MIDLANDS

For Spares Westgate, Aldridge, W Midlands, WS9 8UX.

● **BIRMINGHAM:** All other Post Codes Tel: (0922) 743376

Tel: (0922) 743374

For Spares Ashling Street, NG2 3JB.

● **NOTTINGHAM:** For Service Tel: (0602) 860387

Tel: (0602) 862437/864322 For Spares Tel: (0782) 774511

West Ave, Nelson Estate, Tallis, ST7 1TN. Tel: (0782) 774511

### NORTH EAST

● **HULL:** Custom House Building, Whitefriargate, HU1 2EU. Tel: (0482) 224777

● **NEWCASTLE:** 31 Mosley Street, NE1 1YF. Tel: 091-232-1008

● **WASHINGTON:** 8 Beale House, Tower Road, Glover Est, District: 11, NE37 2SH. Tel: 091-417-3500/419-3535

● **WETHERBY:** Sandbeck Lane, LS22 4TW. For Spares Tel: (0837) 381221

Tel: (0837) 381261/581444 For Spares Tel: (0837) 381221

### NORTH WEST

● **KENDAL:** 44/46 Station Road, Heaton Mersey, Stockport, SK4 30T. Manchester North Tel: 061-432-0513

● **MANCHESTER:** For Service Manchester South Tel: 061-442-8677

For Spares Tel: 061-432-0255

● **MERSEYSIDE:** 40 Cowley Hill Lane, St Helens, WA10 2AD. Tel: (0744) 35152

● **NETHERTON:** 7 Bridle Way, Merseyside. Tel: 051-525-2342/524-2339

● **PRESTON:** 24/25 Cannon Street, PR1 3NR. Tel: (0772) 824311

### SCOTLAND

● **ABERDEEN:** Holbeck House, 68 Carden Place, AB1 1UL. Tel: (0224) 642283

● **EDINBURGH:** 35 West Bowling Green Rd, Leith, EH6 5HX. Tel: 031-554-1431

● **RENFREW:** West Lodge Road, Blythswood Estate, PA4 9EN. Tel: 041-886-6241 For Spares Tel: 041-886-5611

### SOUTH

● **KENT:** Larkfield Trading Est, New Hythe Lane, Larkfield, ME20 6SW. Tel: (0622) 716571 For Spares Tel: (0622) 716651

● **SOUTHAMPTON:** Unit R, S Hampshire Ind Park, Salisbury Rd, Totton, SO4 3SA. Tel: (0703) 861981/867374 For Spares Tel: (0703) 867933

● **SUSSEX:** 1 Kingswood, North St, Hailsham, BN27 1DQ. Tel: (0323) 842733

● **PLYMOUTH:** 69 Mulvey Plain, PL4 6JH. Tel: (0752) 262631

### WALES

● **NORTH:** Conwy Rd, Llandudno Junction, LL31 9RE. Tel: (0492) 862626

● **SOUTH:** 18 Western Ave, Bridgend Ind Estate, Bridgend, CF31 3SL. Post Codes CF, SA & SY23-25 Tel: (0656) 664121

For Service Post Codes BS, G, I (not 55), HR, SY15-18, LD1-8, NP. Tel: (0656) 665554

● **WEMBLEY:** Tel: (0656) 766111

- Service Office and Spares Centre
- Service Office only

<p><b>IRELAND</b></p> <ul style="list-style-type: none"> <li>● <b>NORTHERN:</b> 256 Ormeau Road, Belfast, BT7 2FL. Tel: (0232) 647111</li> <li>● <b>ERE:</b> 49 Airways Ind Estate, Dublin 17. Tel: Dublin 426088 Tel: Dublin 426836</li> </ul> <p>For Service For Spares</p>	<p><b>CHANNEL ISLANDS</b> - Service provided by Agents. Normal Guarantees apply and all Service Schemes are available.</p> <p><b>JERSEY:</b> 19 Don Street, St. Helier. Tel: (0534) 21625</p> <p>or</p> <p>Clos D'Ormees, Pontiac, St Clements. Tel: (0534) 54808</p> <p><b>GUERNSEY &amp; SARK:</b> Valoys Stores, Grande Rue, St Maritins, Guernsey. Tel: (0481) 38422</p> <p><b>ALDERNEY:</b> 22 High Street, St. Peter. Tel: (0481) 822866</p>
<p><b>ISLE OF MAN</b> - Service provided by Agents. Normal Guarantees apply and all Service Schemes are available</p> <p>from</p> <p>5 Drumgold St, Douglas. Tel: (0624) 672233</p> <p>or</p> <p>Cronkbourne Village, Douglas, Guernsey. Tel: (0624) 676066</p> <p>or</p> <p>17 Ridgeway Street, Douglas. Tel: (0624) 25811/25948</p>	<p><b>SHETLAND, ORKNEY &amp; WESTERN ISLES</b> - Service provided by Agents. Normal Guarantees apply, but Service Schemes are NOT available.</p> <p><b>SHETLAND:</b> Fort Road, Lerwick. Tel: (0859) 2557</p> <p><b>ORKNEYS:</b> Heistone Ind Estate, Kirkwall. Tel: (0856) 5457</p> <p><b>WESTERN ISLES:</b> 27 Bayhead Street, Stromoway, Isle of Lewis. Tel: (0851) 3387</p> <p><b>OTHER ISLANDS:</b> Local Hydro Electric Shops. EXCEPT ARRAN, BUTE &amp; SKYE. Which are covered by Hotpoint.</p>

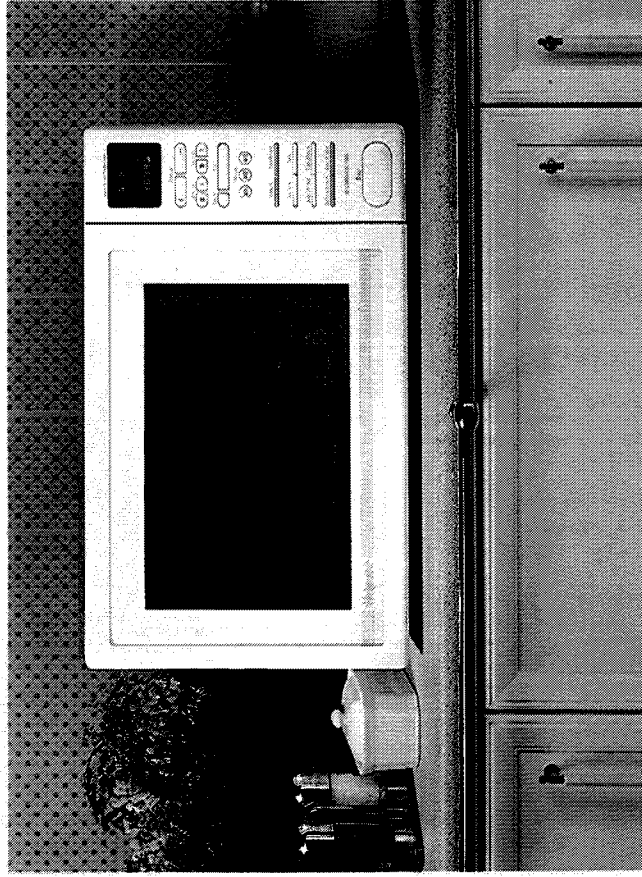

# Hotpoint®

In accordance with its policy of progressive product design, the Company reserves the right to alter specifications.

Hotpoint Ltd, Peterborough, PE2 9JB, England

Printed in England 192

## Your New Microwave Oven

This book is your guide to the use and care of your Hotpoint Microwave Oven. Please take the time to read it **before** you install and use the oven.

### Electrical Requirements

All Hotpoint appliances come complete with a fitted plug. The plug on your Microwave has a 13A fuse. If the plug does not fit your sockets, a new plug can be fitted. Cut off the old plug and throw it away, do not insert it into a socket elsewhere in the house as this could cause a shock hazard.

**WARNING – THIS APPLIANCE MUST BE EARTHED.**

#### **IMPORTANT – Fitting a Different Plug:**

The wires in this mains lead are coloured in accordance with the following code:

Green and Yellow	– Earth
Blue	– Neutral
Brown	– Live

If you fit your own plug, the colours of these wires may not correspond with the identifying marks on the plug terminals. This is what you have to do.

1. Connect the green and yellow (Earth) wire to the terminal in the plug marked 'E' or with the symbol  $\equiv$ , or coloured green or green and yellow.
2. Connect the blue (Neutral) wire to the terminal in the plug marked 'N' or coloured black.
3. Connect the brown (Live) wire to the terminal marked 'L' or coloured red.

With alternative plugs a 15A fuse must be fitted either in the plug or adaptor or in the main fuse box. In the event of replacing a fuse in the plug supplied a 13A ASTA approved fuse to BS1362 must be fitted.

If the plug is the moulded on type the fuse cover must be refitted when changing the fuse. In the event of losing the fuse cover, the plug must **not** be used until a replacement fuse cover has been obtained and fitted. A new fuse cover can be obtained from your nearest Hotpoint Service Office or local Electricity Board. The colour of the correct replacement fuse cover is that of the coloured marks or insert in the base of the plug.

Do not operate this oven if it has a damaged cord or plug, if it is not working properly, or if it has been damaged or dropped.

**Do not** immerse cord or plug in water.

Keep cord away from heated surfaces.

**Do not** let cord hang over edge of table or work surface.

# Hotpoint Service Cover

## Satisfaction Guaranteed or Your Money Back

Hotpoint gives you a unique 'Satisfaction Guaranteed' promise – valid for ninety days after you have purchased your Hotpoint product. If there is a problem with your Hotpoint appliance just call your Hotpoint Service Office. If necessary we will arrange for an engineer to call. If the problem is not resolved by us under this Guarantee, Hotpoint will replace your appliance or, if you prefer, give you your money back. This Guarantee is additional and subject to the terms of Hotpoint's Five Year Parts Guarantee.

## Hotpoint's Free Five Year Guarantee

From the moment your appliance is delivered, Hotpoint guarantees it for **FIVE YEARS**.

- In the Five Years all replacement parts are **FREE** provided they are fitted by our own Service Engineer. During the first year our Engineer's time and labour is also free.
- After the first year we will charge for our Engineer's time and labour. We do, however, operate a range of Service Plans (see opposite) which for an annual payment enables you to cover any repair costs which may be necessary.
- All of our service repairs are guaranteed for twelve months in respect of our labour and any parts fitted.
- The appliance must be used in the United Kingdom and must not be tampered with or taken apart by anyone other than our own Service Engineer.
- You may, however, buy parts which can be safely fitted without specialist knowledge or equipment. The correct fitting of such parts, provided they are genuine Hotpoint spares, will not affect your Guarantee. Parts are available from our main Hotpoint Spares Centres (see back page).
- Our Guarantee does not cover the cost of any repair which is needed because of power cuts, accidents or misuse. Nor does it cover the cost of any visit to advise you on the use of the appliance. Please read the instruction book thoroughly.
- If at any time during the Guarantee period we are unable to repair your appliance, we will refund any repair costs paid to us in the previous twelve months. We will also offer you a new appliance at a reduced charge instead of a repair.
- Our Guarantee is in addition to and does not affect your legal rights.
- Should you need independent advice on your consumer rights, help is available from your Consumer Advice Centre, Law Centre, Trading Standards Department and Citizens Advice Bureau.

# Contents

	Page
Electrical Requirements	2
Unpacking and Installing your Microwave Oven	4-7
Technical Information	8-9
Get to know your Microwave Oven Control Panel	10
Operating your Microwave Oven	11
Setting the Oven Controls	12
Setting the Clock	13-22
Setting Power Level	13
Setting Cooking Time	14
Setting Cook Weight	15
Setting Auto Defrost	15-16
Setting Defrost Weight	17
Setting Auto Repeat	17-18
Sending End Time	18
Setting Memory Keys	19
Programming Combinations	20-21
Using the Turntable	21
Using the Extra Minute	22
Heat and Hold feature	22
Safety Rules	22
Caring for your Oven	23
If your Oven won't work	24
Hotpoint Service Cover	25
Hotpoint Service Offices	26
	back page

## Retention of this Instruction Book

This Instruction Book must be kept handy for reference as it contains important details on the safe and proper use of the appliance.

If you sell or pass the appliance to someone else, or move house and leave it behind, make sure this Book is also provided so the new owner can become familiar with the appliance and safety warnings.

If the Book is lost or damaged a copy may be obtained from Hotpoint Ltd, Celta Road, Peterborough, PE2 9JB.

- All Hotpoint servicing is done by our own Service Organisation located throughout the United Kingdom and Southern Ireland. It will be happy to deal with any problems.

## Hotpoint's Service Care

Whether you have just one or a number of Hotpoint appliances in your kitchen Hotpoint has a range of Service Schemes to give you complete peace of mind.

## Service Cover

One annual payment covers you for all repairs for **individual appliances**. If two or more appliances are covered a 20% reduction is made on each fee. There is also the option of **Service Cover with Maintenance** at an additional cost. Service Schemes are renewable each year by mutual agreement.

## Cooker Cover

One annual payment covers you for all repairs for **any number of Hotpoint Ovens, Microwaves, Hobs and Cooker Hoods** purchased. There is also the option of **Cooker Cover with Maintenance** at an additional cost.

## Kitchen Cover

One annual payment covers you for all Repairs and a Maintenance Check for **all Hotpoint appliances owned** which are less than ten years old. Kitchen Cover also covers loss of food up to the value of £250 in our refrigerator and freezer products. Any additional Hotpoint appliances purchased after you have joined **Hotpoint Kitchen Cover** will automatically be included during the current annual period of cover without any further charge.

## Appliance Registration

To ensure that you have the opportunity to benefit from any of the above Service Schemes you should complete and return immediately the Appliance Registration Form supplied with your appliance. Full details and costs of our Service Schemes together with an application form will be sent to you at the end of the first year of the guarantee.

## Annual Safety/Maintenance Checks

Hotpoint strongly recommends that all its appliances are regularly checked for electrical and mechanical safety whether or not they are covered by a Service Plan.

## Proof of Purchase

For future reference please attach your purchase receipt to this booklet and keep it in a safe place.

## Spares and Accessories

Spares and accessories can be ordered from your local Hotpoint Spares Centre (listed on the back page), using the order form enclosed.

## Unpacking the Microwave Oven

1. Make sure all the packing materials are removed from inside the door.
  2. Inspect the oven after unpacking for any visual damage such as:
    - Misaligned Oven Door
    - Damaged Oven Door
    - Dents or Holes in Oven Window and Screen
    - Dents in Cavity.
- If any of the above are visible, DO NOT use the oven, and report the damage to your HOTPOINT dealer.

## Installing the Microwave Oven

Your Microwave Oven can be installed in one of three ways:

1. Freestanding
2. Built-in on its own.
3. Built-in above a Hotpoint single oven (Models 6117 B/P, 6111 B/P, 6102 B/P, 6122 B/P and 6142 B/P).

### 1. Freestanding Use

- a) The oven weighs 23kg (51lb) and must be placed on a horizontal surface strong enough to support this weight.
- b) Keep away from direct exposure to high temperatures and steam, i.e. do not place it next to your cooking hob or a kettle.
- c) Do not place anything on top of the oven.
- d) To provide adequate ventilation keep the sides of the oven 5cm (2in) away from any wall, 10cm (4in) away from the

underside of an overhead kitchen cupboard and 10cm (4in) away from rear wall to ensure the correct ventilation.

e) DO NOT remove the plastic disc on the turntable drive shaft.

### 2. Built-in use

The oven can be built-in on its own or, above or below a Hotpoint single oven. This must be done with the building-in kit supplied.

### WARNING

Only install Hotpoint single ovens, Models 6117 B/P, 6111 B/P, 6102 B/P, 6122 B/P and 6142 B/P.

### Cabinet Preparation

To avoid any risk of the housing cabinet toppling, it must be fixed to the wall.

The shelf for the microwave oven must be strong enough to support a weight of 100lb (45kg), and should be constructed of 15mm thick plywood, chipboard or similar.

The main power socket must be located so that the supply to the microwave oven can be isolated by the user if necessary without removing the oven from its location. This location must be as close as possible to the oven but care must be taken that the main cable is not located in close proximity to cooking areas. Re-siting or the provision of a main socket should be carried out by a competent electrician or your Electricity Board.

The microwave oven must be disconnected from the power supply before attempting the installation.

## If your Oven won't work

... don't panic

Just quickly check these points before calling a Hotpoint engineer.

1. If the oven does not work at all:
  - Check that the oven is correctly plugged in and that the mains supply has been switched on.
  - Check that the wall socket is working properly by plugging in another appliance.
2. If the microwave power will not come on:
  - Check that the door is securely closed and that the timer is set.

If, after following these instructions, you are still having problems contact your nearest Hotpoint Service Office. The telephone number is shown on the back page: When you contact us we need to know:

1. Your name, address and post code.
  2. Your telephone number.
  3. Clear and concise details of the fault.
  4. The model number 6660.
  5. When it was purchased.
  6. Put the date here .....
  6. If you have subscribed to the Hotpoint Service Cover Plan.
- Make sure you have all these details before you call. Meanwhile, switch off the appliance at the mains supply and leave it alone until the Engineer calls.

## Spare Parts

Please remember your new appliance is a complex piece of equipment.

'DIY' repairs or unqualified and untrained service people may put you in danger, could damage the appliance and might mean you lose cover under Hotpoint's Parts Guarantee.

If you do experience a problem with the appliance don't take risks; call in Hotpoint's own Service Engineer. The address and telephone number of your nearest Hotpoint Service Office is in your local telephone directory.

Our spare parts are designed exclusively to fit only Hotpoint appliances. Do not use them for any other purpose as you may create a safety hazard.

# Caring for your Microwave Oven

## Cleaning and Maintenance

Cleaning your microwave oven is easy!

After every use just wipe the inside of the oven with a soft damp cloth and mild detergent (washing up liquid). Wipe out well and dry!

## FOR MORE STUBBORN STAINS:

1. **Oven Walls and Floor** – To keep the oven in tip-top operating condition, clean the oven with a damp cloth after each use. Always use a soft cloth, never an abrasive powder or pad. If time has elapsed between cleaning and food particles have dried-on, let a cup of water boil for about 3 minutes in the oven. The steam build up will soften the dried-on particles.

2. **Turntable Tray** – This can be removed from the oven and washed either by hand or in the dishwasher. Handle with care – it's glass, therefore breakable!

3. **Inside of Oven Door** – This area is part of the sealing system which prevents microwave leakage. It is extremely important that the door be kept clean at all times.

4. **Oven Front Face** – This is also part of the door seal. It must be kept clean at all times.

5. For brown and burnt deposits it may be necessary to use a more abrasive product, ie. a special microwave oven cleaner.

6. Do not use any abrasive substances on the door seals, hinges or distribution cover.

## Outside the Oven

1. **The Outer Casing** – This is easily cleaned with a damp cloth.

2. **The Door** – This should be cleaned with a damp cloth. **DO NOT** use any abrasives as this may scratch the surface and impair vision into the oven.

## Do Not

USE ANY ABRASIVE SCOURING PRODUCTS.

USE ANY COMMERCIAL OVEN CLEANERS.

USE ALKALINE CLEANER ON ANY POINTED/COATED AREAS OF THE OVEN.

## NOTE

WHEN CLEANING, THE OVEN MUST BE SWITCHED OFF.

# Instructions for Building-in Microwave

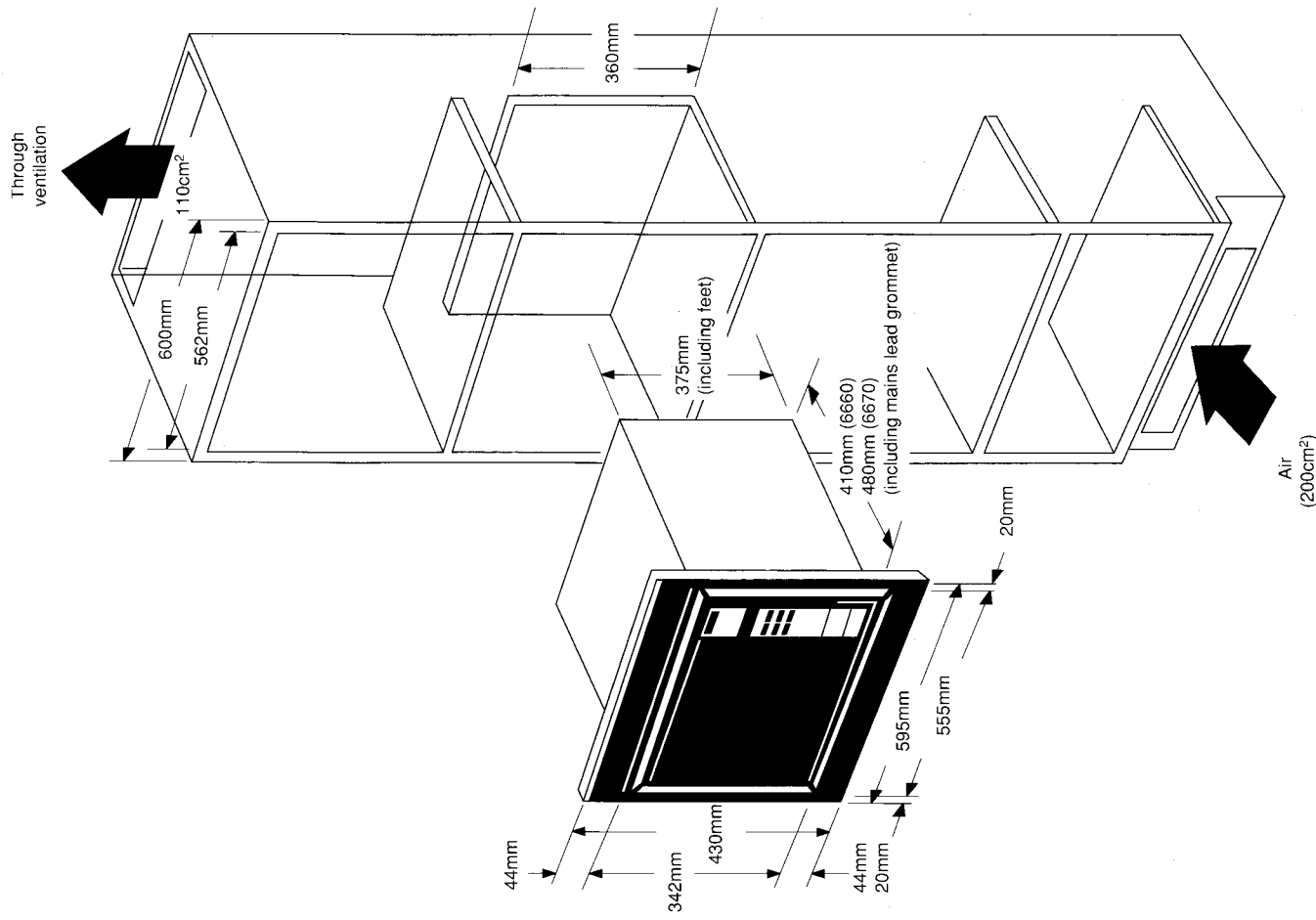

## Safety Rules

- DO NOT allow anyone to service the oven other than an Authorised HOTPOINT Service Agent. To do so will void the warranty. It is dangerous for anyone other than a service engineer trained by HOTPOINT to perform repairs on it.
- DO NOT, under any circumstances, remove the outer cover, door or control panel. This too will void the warranty.
- DO NOT place any object between the front plate of the oven and the door.
- DO NOT operate the oven if the door seal is damaged or the door does not close properly. Inspect these areas for damage. If there is any damage the oven must not be operated until it has been repaired by a service engineer trained by HOTPOINT.
- DO NOT operate the oven on microwave setting when empty, as this may damage the oven.
- Always keep the door seals (inside of the door and the oven front plate) clean by wiping regularly with a damp cloth and mild detergent, so that any grease, soil or spatters are not allowed to build up.

A. Mark the centre of the front edge of the microwave housing cabinet.

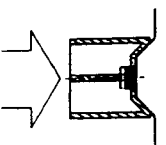
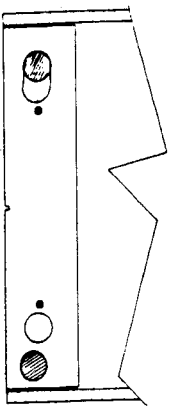
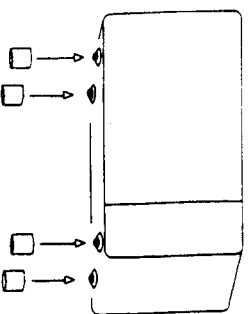
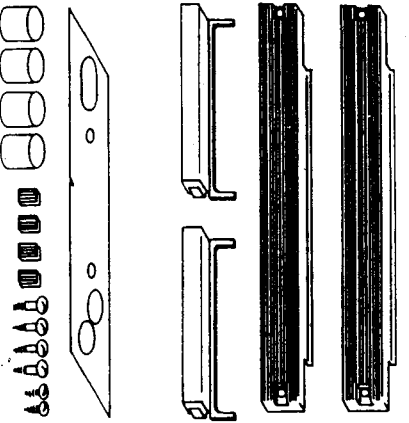
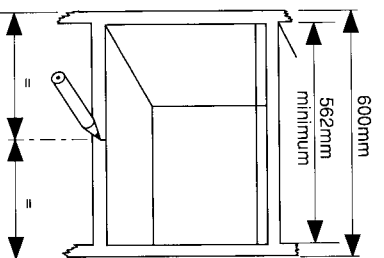

C. Put the four supports onto the feet of the microwave oven.

B. Line the notch in the metal retaining plate with the centre of the housing cabinet and screw the plate into position.

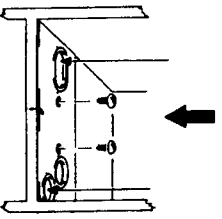

- The HOTPOINT Microwave Oven is designed to give long, safe and satisfactory service. With it, as with many electrical appliances, there are some basic rules to follow to assure peak performance.
- DO NOT use a metal container when using the microwave function as microwaves cannot penetrate metal. It is not advisable to use utensils with gold or silver trim as these may cause arcing in the microwave oven. Porcelain or glass are suitable as containers.
  - DO NOT cook eggs in their shells. The expansion and build up of pressure could cause the egg to explode. After cracking and removing the egg from the shell always pierce yolk with a fork or skewer before frying or poaching.
  - DO NOT cook food in a bottle or sealed container.
  - DO NOT cook food with a shell such as a chestnut. Make a split in the shell with a kitchen knife.
  - DO NOT use the oven for any other purpose than cooking (eg. Drying clothes).
  - DO NOT insert any object into the opening on the outer case.
  - DO NOT touch, or allow any object to cover the openings on the top of the outer case during cooking.
  - DO NOT heat oil or fat for deep frying in a microwave oven, it may overheat.
  - Liquids must be briskly stirred or poured (to mix in air) before being heated in a microwave oven. If air is not mixed into a liquid, it can vigorously boil over in the oven, or delayed eruptive boiling of it may occur after removal from the oven.
  - Plastic or paper containers designed for microwave use should only be used for short cooking periods.
  - DO NOT use the oven cavity for any type of storage, such as paper, cookbook, etc.
  - Avoid heating baby foods in their glass jars; transfer to a container suitable for use in a microwave oven.
  - Only use browning dishes or skillets specifically designed for use in a microwave oven. Do not go over manufacturers' recommended pre-heat times.
  - Never lean on the door or allow a child to swing on it when the door is open. Injury could result.
  - To reduce the risk of fire in the cavity;
    - Do not overcook food. Carefully attend oven if paper, plastic or other combustible material is placed inside the oven to facilitate cooking.
    - Remove wire twist-ties from plastic bags before placing in oven.
    - Do not use recycled paper products in this oven. Impurities in these products can cause arcing which may result in fire.
  - If materials inside the oven should ignite, keep oven door closed, turn oven off, and disconnect the power cord or shut off power.

## TURNTABLE BUTTON

You can select not to use the turntable if you wish to use large dishes which require the full oven area. However, the dish must then be rotated, or the food mixed, halfway through cooking.

To stop the turntable simply press the turntable button after programming and before pressing start.

## EXTRA MINUTE BUTTON

This button allows for extending the cooking time at maximum power level (9) from 1 to 3 minutes, or for carrying out fast programming when the time corresponds to 1, 2 or 3 minutes.

Press the 'Extra Minute' Button once, twice or 3 times according to the time required and then press the 'Start' button.

## HEAT AND HOLD FEATURE

This feature keeps the food at the same temperature after the cooking time is over. After each programme, a three beep alarm sounds, the ventilator still operates and the turntable continues to rotate. If the door is not opened after 5 minutes, the oven will continue to heat intermittently for a period of 10 minutes and the display will indicate the time of day.

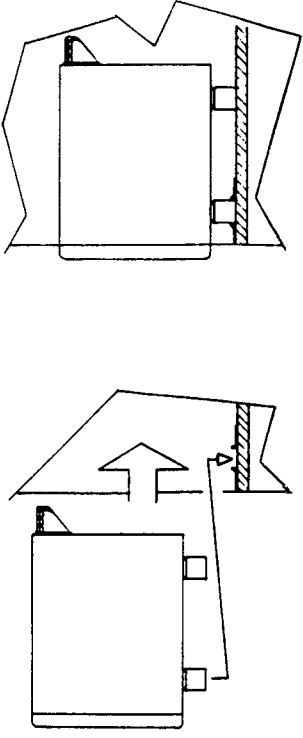

D. Put the microwave into the housing cabinet locating the front feet supports in the hole and slot in the metal plate screwed to the cabinet.

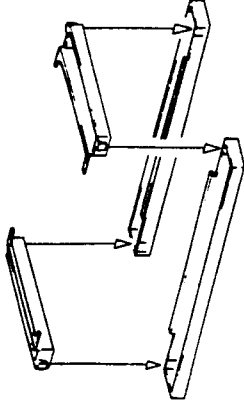

E. Clip the edges of the fascia surround together.

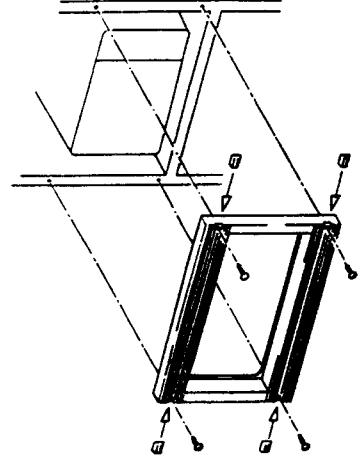

F. Screw the fascia surround to the edges of the housing cabinet

# Technical Information

Power supply	Frequency Voltage Consumption High:	50Hz 240V AC, Single Phase 1350 watts (approx)
Microwave	Output Frequency	*850 watts max new rating (750 watts old rating) 2450MHz
Dimensions (including building-in kit)	Outer Height Width Depth	379mm (15in) 595mm (27 1/2in) 387mm (15 1/5in)
	Inner Height Width Depth	247mm (9 7/16in) 360mm (14 1/5in) 360mm (14 1/5in)
	Capacity – usable volume	32 litres (1.1 cu ft)
Timer	0-99 mins 99 secs	
Net weight	23kg (51lb)	

## Radio Interference Regulations

This apparatus has been produced to comply with BS800: 1988.

### \*NOTE

Microwave Output Power varies by output power measuring method.

Currently almost all microwave oven output power is measured according to the IJS Standard. But recently it has been decided to use the IEC 705 Standard as a common measuring method here in Europe.

If you are following recipes other than from the Hotpoint cookery book supplied or food manufacturers' instructions care must be taken to follow the correct timings.

If the ratings have been calculated using the IEC 705 method you need to follow 750W timings. If this is not made clear, contact the food

manufacturer or publisher to clarify before cooking.  
The IEC705 rating will eventually be adopted by all manufacturers and cookery writers. Until this time take care to follow the correct instructions.

## Caution

1. Please remember that in the microwave mode the oven only heats the liquids in a container rather than the container itself. Therefore, even though the lid of a container is not hot to the touch when removed from the oven, please remember that the food liquid inside will be hot and will release the same amount of steam and or spitting when the lid is removed as in conventional cooking.

2. Always test the temperature of cooked food yourself especially if you are heating or cooking food

## TO USE MEMORY KEY

Touch Memory  pad.

The program which is set into MEMORY 1 will appear in the display automatically.

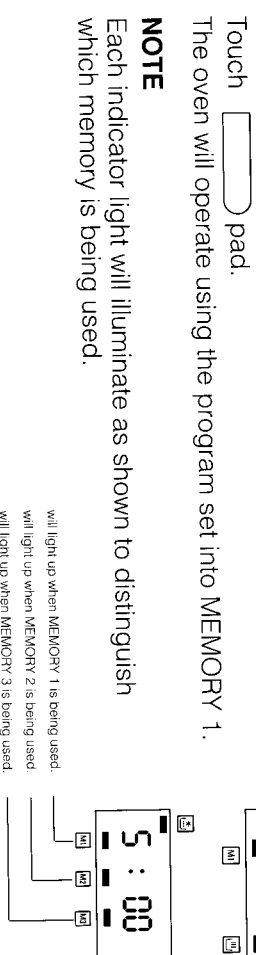

## Programming Combinations

This oven has the ability to be programmed to do up to three consecutive functions. These combinations are given below and either the complete program or part of it can be used.

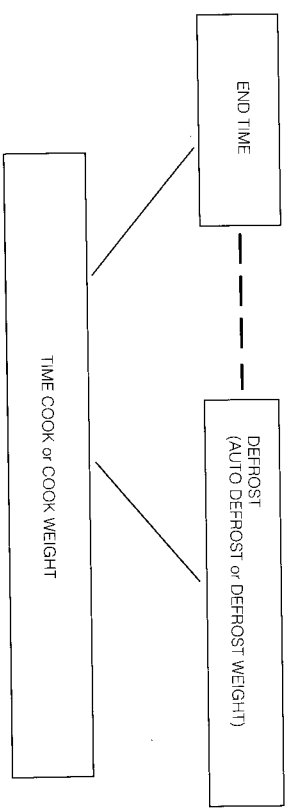



### Memory Key

1. This oven has three memory functions.
2. Each of these memory functions (M1) (M2) (M3) can store two separate programs, (eg. Auto Defrost – Microwave Cooking) or to store any individual program.
3. The memory functions are designed for convenience when repeating the same program.

### TO SET THE MEMORY

Example: Set the following program in MEMORY 1.

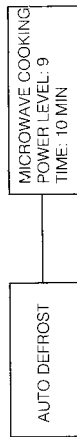

Touch **AUTO DEFROST** pad to set **AUTO DEFROST** and touch numeral pad to set defrosting time.

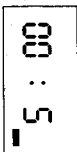

Touch **POWER LEVEL** pad to set power level.

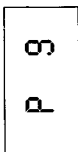

Touch numeral pad to set cooking time.



Touch **MEMORY** (M1) pad.

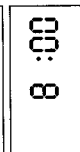

Now the above program is set into **MEMORY 1**.

And present time will appear in the display.

### NOTE

If you want to set the above program into **MEMORY 2** or **3**, touch **MEMORY** (M2) or (M3) pad instead of **MEMORY** (M1) pad. When the oven is unplugged or the

liquid for babies. It is advisable never to consume food liquid straight from the oven but allow it to stand for a few minutes and stir food/liquid to distribute heat evenly.

3. Food containing a mixture of fat and water, eg. stock, should stand for 30-60 seconds in the oven after it has been turned off. This is to allow the mixture to settle and to prevent bubbling when a spoon is placed in the food/liquid or a stock cube is added.

4. Always follow the cooking instructions detailed in our cookbook when preparing/cooking food/liquid and remember that there are certain foods, eg. Christmas puddings, jam and mincemeat, which heat up very quickly, in the microwave mode. When heating or cooking foods with a high fat or sugar content do not use plastic containers.

5. Cooking utensils may become hot because of heat transferred from the heated food. This is especially true if plastic warp has been covering the top and handles of the utensil. Oven gloves may be needed to handle the utensil.

6. Do not use re-cycled paper products in this oven. Impurities in these products can cause arcing.

power supply is switched off, the memory will be erased and will need to be reset.

The memory will not be erased by the clear pad.

To store a new program:

1. Set the new program required (eg. Microwave Cooking Power Level: 9 Time: 10 min.)
2. Touch any of the memory pads (M1) (M2) (M3) and the new program will be retained; whatever was previously stored in that memory will be erased.

# Get to know your Microwave Oven

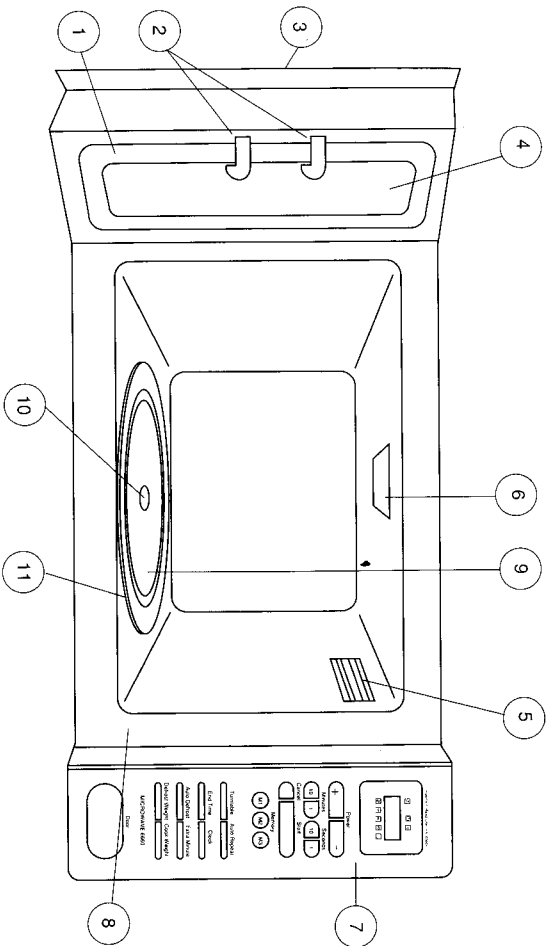

1. Choke Door Seal
2. Door Locks
3. Oven Door
4. Oven Window
5. Oven Light
6. Microwave Distributor Cover
7. Control Panel
8. Oven Front Plate
9. Turntable Tray
10. Spindle (under turntable tray)
11. Roller Ring (under turntable tray)

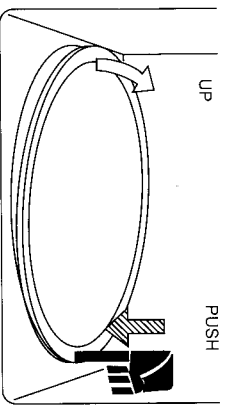

## NOTE

When you place the Turntable Tray into the oven, ensure the roller ring and the spindle are in position.

Place the tray onto the spindle and roller ring.

DO NOT forcibly rotate the Turntable Tray.

When cooking several individual items, such as potatoes, they can be placed directly on the tray leaving an equal space between them for even cooking.

– **DO NOT** remove the turntable tray when any item of food or any dishes etc. are placed on it

– Remove with care as the turntable tray can get hot during cooking.

## TO SET THE END TIME FUNCTION

Your oven has an END Time feature which means that the oven can be programmed to **FINISH** cooking at a pre-set time.

Because the oven is set to finish cooking at a specific time of the day, the clock must always be correct.

Example: Set End Time of 12:30 to cook on power level 5 for 5 minutes.

Touch **End Time** pad.

**END TIME** Indicator

Light will light up and “: 0” will appear in the display window

Touch numeral

pads. (For setting the End time, the MIN pads set the hours and the SEC pads set the minutes.)

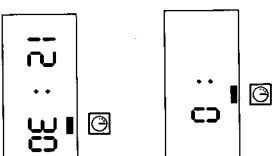

Touch **MIN** pad once ..... “10:00” will appear

Touch **MIN** pad twice ..... “12:00” will appear

Touch **SEC** pad three times ... “12:30” will appear

Touch **POWER** pad to set power level.

Touch numeral pad to set cooking time.

Touch **Start** pad. The present time will appear in the display window.

To check End time Touch **End Time** pad. End time is indicated for 5

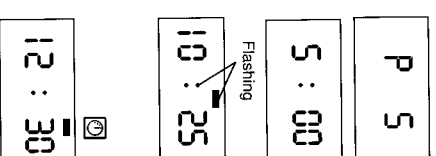

seconds.  
The oven will finish cooking at 12:30.

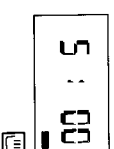

The Heat and Hold feature will operate for 15 mins to keep the food hot after the cooking time.

If the oven door is opened, the END TIME indicator stops flashing. AFTER CLOSING THE DOOR, START PAD MUST BE TOUCHED AGAIN SO THE OVEN WILL FINISH COOKING AT A PRE-SET TIME.

If it is necessary to reset the End time, touch the **Cancel** pad and start again.

If it is necessary to cancel the end time, touch the **Cancel** pad.

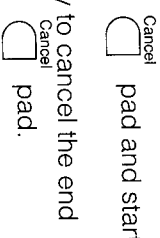

## TO SET DEFROST WEIGHT

Select DEFROST WEIGHT program from d1-c3.

Obtain the weight of the food to be cooked.

Use the minutes and seconds buttons to programme the weight

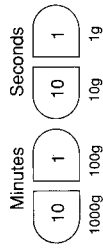

Example: Set DEFROST WEIGHT program d3 to defrost 1350g.

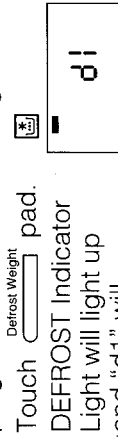

and "d1" will appear in the display window.

To select programs d2-c3 repeat until required number is shown on in the display.



Touch numeral pads.

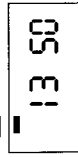

Sec pad once ..... "10:00" will appear

Min pad three times ... "3:30" will appear

Min pad five times ..... "13:50" will appear

Start

Touch pad.

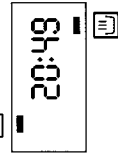

The oven will now automatically calculate the defrosting time necessary and this will be shown up in the display.

## Control Panel

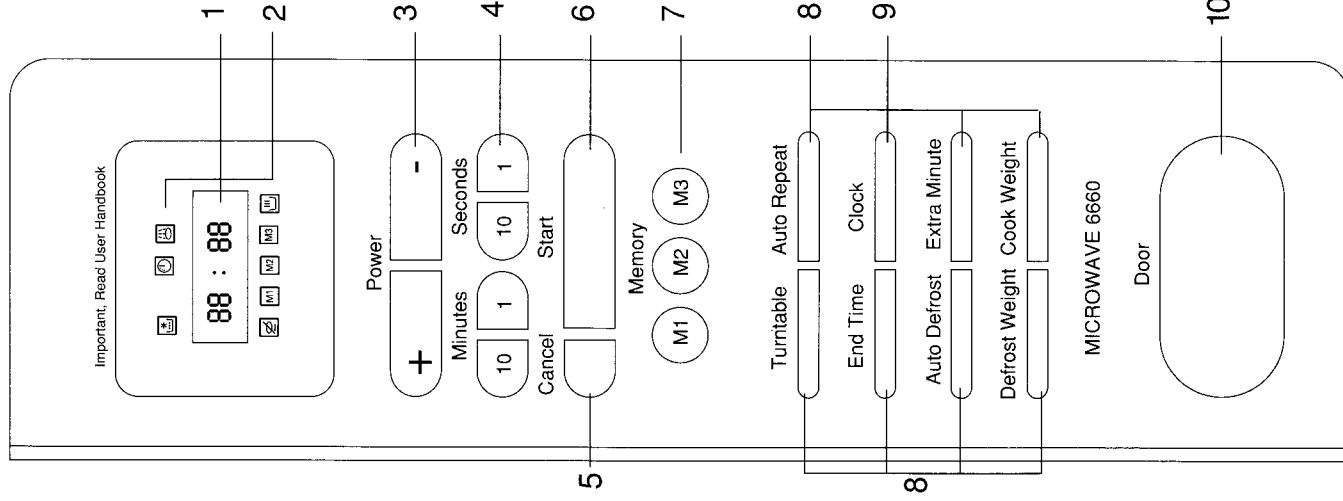

### 1. Fluorescent Display

Indicates cooking time, power level and other microwave features.

### 2. Indicator Lights

Indicates selected operation mode.

### 3. Microwave power level pads

Used to set desired power level.

### 4. Numeral Pads

Used to set cooking times, clock time and weight of food.

### 5. Cancel Pad

Used to clear all information previously put into oven control panel except the clock and memory.

### 6. Start Pad

Used to start selected operations except the clock.

### 7. Memory Pads

Used to recall set programme.

### 8. Function Pads

Used to set the desired oven operation.

### 9. Clock Pad

Used to set and recall time of day.

### 10. Door opening button

Push to open the door.

## NOTE

1. The display will be repeated d1-d2-c3 and back to d1 by touching DEFROST WEIGHT pad.

2. When using DEFROST WEIGHT, then maximum weight that can be set is 3999g. (See information charts in cookery book for recommended maximum weights for individual food items.)

## TO SET AUTO REPEAT

To repeat an identical program ie. Power Level and Time, instead of having to reprogram the instructions manually, selected the auto repeat button which will automatically select the last instruction programmed into the oven. Touch the "start" pad to commence the cooking process.

Example: The oven had been previously set to cook on Power Level 9 for 6 minutes.

Touch Auto Repeat pad.

Touch Start pad.

The oven will now cook on Power Level 9 for 6 minutes.

If the Cancel pad was touched during the cooking time or at the end of the program, the oven will still hold the information enabling "Auto Repeat" to still be used.

If after selecting "Auto Repeat" any pad other than "START" is touched, the last cooking cycle will be deleted and "Auto Repeat" will not work.

# Operating your Microwave Oven

Your Hotpoint Microwave Oven is easy to operate.

## OPERATION

1. Push the 'DOOR' button.

RESULTS  
Door springs open.

2. Place the food, or food in its container, on the Turntable Tray.

3. Close the door. The latch will snap shut, automatically locking the door. If the door is not closed properly, the oven will not start.

4. Set the Oven Control, as instructed on the next pages, "SETTING THE OVEN CONTROLS".

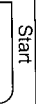
5. Touch  pad.

The oven will start cooking, and the Cooling Fan, Turntable Tray, Oven Light and Cook Indicator Display will come on.

6. End of Cooking Cycle:

1. The Timer switches off.  
\*Heat and Hold feature operates.

The beeper will sound three times. If the door is not opened after 5 mins, the oven will continue to heat intermittently for a period of 10 mins.

The oven will automatically shut off, and the Cooling Fan, Turntable Tray, Oven Light, the Cook Indicator Display will turn off, and Clock will reappear on the display.

2. Open the door during cooking.

The oven will automatically shut off. The Cooling Fan, Turntable Tray and Oven Light will turn off and the Cook Indicator Display will stop at the cooking time remaining. The oven will not restart until the door is closed and the  pad is pushed again.

3. Touch  pad during cooking.

The oven will automatically turn off: the Cooling Fan, Turntable Tray, Oven Light and the Cook Indicator Display will turn off. To resume cooking the Oven must be reset.

4. 1. Touch "POWER LEVEL." pads during cooking.  
2. Touch "Auto Defrost" pad during auto defrosting

The oven will automatically turn off: The Cooling Fan, Oven Light, Turntable Tray and the Cook Indicator Display will turn off at the cooking time remaining. Touch the  pad to resume cooking.



## TO SET AUTO DEFROST (DEFROST BY TIME)

Example: Set the oven to defrost for 3 minutes 30 seconds.

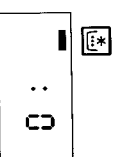
Touch  pad. DEFROST Indicator Light will light up.



Touch numeral pads.

 pad three times ... "3:00" will appear  
 pad three times ... "3:30" will appear

Now touch

the  pad. COOK Indicator Light will light up.

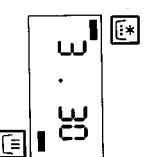

The auto-defrost function is designed to defrost by automatically utilising three different power levels. It begins defrosting on a medium high power level to quickly activate defrosting. The middle program defrosts on a medium-low power level. The last program of the AUTO-DEFROST is on a low power level to ensure equalisation of defrosting action throughout the food. Once the oven is started, it will gradually defrost the food and power level will automatically reduce during the defrosting time. This will eliminate or reduce the normal required standing time.

**NOTE**  
The "Auto Defrost" program can only be used for up to 450g/1lb in weight.

## DEFROST WEIGHT

This will enable you to defrost by weight selections of food by use of the 3 programs.

## DEFROST WEIGHT

d1 – Poultry  
d2 – Meat  
d3 – Fish

## NOTE

- Details of recommended maximum weights for each program are given in the accompanying cookbook.
- Place the item of food on a microwave roasting rack (not supplied with oven) or directly on the turntable.
- For meat and poultry weighing more than 499g/1lb 4oz (approx) it is necessary to turn during the cooking cycle for good results.
- For meat and poultry weighing more than 499g/1lb 4oz (approx) allow 20 minutes standing time.
- For meat/poultry/fish less than 499g/1lb 4oz (approx) allow 5 minutes standing time.
- For fish more than 499g/1lb 4oz (approx) allow 10 minutes standing time.
- Always ensure that all meat/fish/poultry is thoroughly defrosted before cooking.

## TO SET COOK WEIGHT

Select COOK WEIGHT program from programs C1-C8.

Obtain the weight of the food to be cooked.

Use the minutes and seconds buttons to programme the weight.

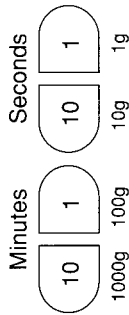

Example: Set COOK WEIGHT program C4 with 1350kg.

Example of Display

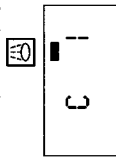

Indicator Light will light up and "C1" will appear in the display window.

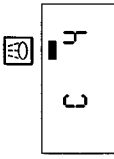

Touch COOK WEIGHT pad to select programs C2-C8 until required number is shown on in the display.

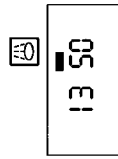

Touch numeral pads (to set the weight of the food in grammes.)

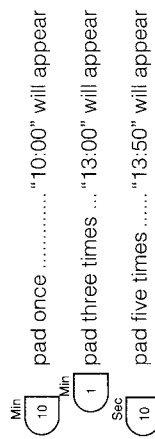

"13:50" will appear in the display window.

Touch Start pad.

The oven will now automatically calculate the cooking time necessary and this will be shown up in the display.

### NOTE

- The display will be repeated C1, C2, C3, C4, C5, C6, C7, C8 and back to C1 by touching COOK WEIGHT pad.
- When using COOK WEIGHT, the maximum weight that can be set is 3999g. (See cookery book

## Setting the Oven Controls

This section covers the mechanics of setting the oven controls and gives you a practice run before you start cooking for real.

Remember the following points:

- The oven door can be opened at any time and the microwave power will be automatically cut off.
- When you press a pad, a beep will sound to confirm that the instruction has been received.
- The time of day automatically returns to the display window when the oven turns off.
- Pressing the CANCEL pad erases all information given to the oven, except the clock and memory.
- Do not START the oven when empty.

Make sure the oven is properly installed and plugged in.

### SETTING THE CLOCK

When the oven is plugged in, "1:01" will appear in the display window. This clock is a twenty-four hour clock, so from 23:59 it will go to 0:00.

## TO SET TIME OF DAY

Example 13:45 24hr Clock.

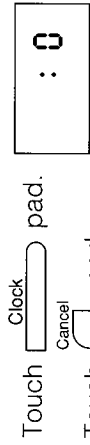

Touch Clock pad.

Touch Cancel pad within 5 seconds.

"0" will appear in the display window.

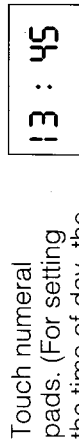

Touch numeral pads. (For setting the time of day, the MIN pads set the hours and the SEC pads set the minutes.)

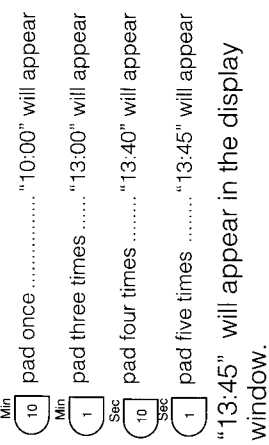

"13:45" will appear in the display window.

Touch Clock pad again.

The two dots between the hour and the minutes will flash every other second.

To reset the time of day, repeat the steps given above.

To check time of day while oven is operating, touch the Clock pad and the time will be displayed for 5 seconds.

# Microwave Cooking

## NOTE

To ensure the best microwave and defrost results, be sure to start with a cool oven. There are 9 power levels which add choice and versatility to your microwave cooking. At power level 9 microwaves are generated all the time the oven is switched on. When other power levels are selected the power is pulsating and this is indicated by a clicking noise.

## Recommended uses for the 9 power level settings

### PL.9 High

This is full power. It is used for fast cooking and is ideal for cooking jams, vegetables, fruits, fish, pasta, drinks, chutneys, beefburgers, bacon, and sealing some joints of meat. Some cake cookery is done at this level and preheating a browning dish.

### PL.8 Reheat

This is best used for reheating foods, but some recipes will use PL.8 as opposed to PL.8.

### PL.7 Roast

Roast joints of meat, ie. lamb, pork, gammon. Cooking all poultry joints or portions. Cooking chops, steak and sausages. Cheese cookery.

### PL.6 Bake

Cakes. These can be finished off on PL.9.

### PL.5 Medium

Egg cookery, delicate puddings, Christmas pudding and recipes using cream.

### PL.4 Simmer

Ideal for simmering the cheaper cuts of meat in stews or casseroles, milk puddings, preparing stock, broth and soups. Cooking joints of beef.

### PL.3 Defrost

Is the suggested level for defrosting, but some slow cooking can be done on this level.

### PL.2 Warm

When the meat in casseroles needs to be very, very tender, then PL.2 can be used for the second half of the cooking.

### PL.1 Low

Softening cheese or butter from the refrigerator. Softening butter for creaming in cake baking. Proving bread.

## TO SET POWER LEVEL

This oven has 9 power levels.

If  is touched, P9 will appear and will count down from power level 9.

If  is touched, P0 will appear and will count up from power level 0.

Example: Set oven to cook at power level 6.

Touch POWER pad.

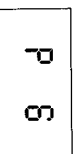

 pad ... Count down from power level "9"

(Touch pad 4 times.)

 pad ... Count up from power level "0" (Touch pad 7 times.)

6 will light up in the Fluorescent Display.

NOW PLACE A CUP OF WATER IN THE OVEN AND CLOSE THE DOOR. FOLLOW THE OPERATING INSTRUCTIONS BELOW. DO NOT ALLOW THE CUP OF WATER TO BOIL DRY – REFILL, IF NECESSARY.

## TO SET COOKING TIME

The timer can be set for up to 99 minutes 99 seconds for microwave cooking.

Example: Set oven to cook for 33 minutes 33 seconds.

Touch POWER pad. (To set power level)

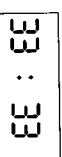

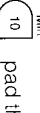
Touch numeral pads.  pad three times ... "30:00" will appear

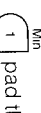
 pad three times ... "3:00" will appear

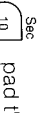
 pad three times ... "33:30" will appear

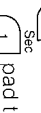
 pad three times ... "33:33" will appear

"33:33" will light up in the Fluorescent Lamp Display.

The oven is now set for 33 minutes 33 seconds at power level 6.

Now touch the  pad to commence the cooking operation.

Cook Indicator Light will light up. 

## NOTE

Should a mistake have been made in setting the timer or power level,

touch the  pad and start again.

Should food be cooked and removed from the oven, before the set time is completed (ie. 1 min still shows on the display) touch  pad before cooking a further item.

If a mistake in the power level or time settings is noticed before cooking has started, the values can be reset. If the

mistake is noticed after cooking has started, touch the clear pad and reset both the power level and time. Cooking time cannot be set unless power level is set previously.

## COOK WEIGHT

This will enable you to cook a selection of food by weight using 8 programs.

## COOK WEIGHT MENU GUIDE

- C1 Potatoes (whole or pieces)
- C2 Carrots, leeks, cabbages ... (thinly sliced)
- C3 Fish (single portion, sliced or filleted)
- C4 Poultry (whole or pieces)
- C5 Coffee, tea, milk, soups
- C6 Tinned food, pre-cooked dishes
- C7 Left overs and chilled pre-cooked dishes
- C8 Pre-cooked dishes and frozen vegetables

## NOTE

1. The maximum weights for each program are given in the accompanying cookbook.
2. Cook meat/poultry on a microwave roasting rack (not supplied with oven) or directly on the turntable.
3. Cover all meat/poultry with a split roasting bag.
4. Turn meat/poultry halfway through cooking time.
5. For program 1
  - a) Prick potato skins.
  - b) Wrap each potato in kitchen paper (not recycled).
  - c) Place potatoes on turntable.
  - d) Do not cook any more than 4 medium sized potatoes at any one time.
6. Allow 20 minutes standing time for meat/poultry over 450g.
  - Allow 5 minutes standing time for meat/poultry under 450g.
7. Always ensure that meat/poultry are cooked thoroughly, continue cooking on variable power and time if the desired result is not achieved after the Cook Weight program.